









Location:

# SYMMONS® Origins®

the smart choice™

S-9606-PLR  
Tub/Shower/Hand Shower System  
**Specification Submittal**



| Specification  | Modifications  |
|--|--|
| <p>Tub/shower/hand shower system powered by the Temptrol® Pressure Balancing valve with integral diverter. Tub/shower/hand shower system shall include adjustable stop screw to limit handle turn, 36" slide bar, separate dual outlet diverter, non-diverter tub spout, in-line vacuum breaker, 60" flexible metal hose, ADA hand shower, 1 mode showerhead with easy to clean rubber nozzles and standard 2.5 gpm (9.5 L/min) flow restrictors. Components shall be made from metal and nonmetallic construction, plated in standard polished chrome finish.</p>   | <ul style="list-style-type: none"> <li><input type="checkbox"/> <b>CG</b> -1.5 1.5 gpm (5.7 L/min) flow restrictor</li> <li><input type="checkbox"/> -2.0 2.0 gpm (7.6 L/min) flow restrictor</li> <li><input type="checkbox"/> -72 72" hose in place of 60" hose</li> <li><input type="checkbox"/> -143 3 mode showerhead in place of standard head</li> <li><input type="checkbox"/> -145 5 mode showerhead in place of standard head</li> <li><input type="checkbox"/> -231 Super showerhead in place of standard head</li> <li><input type="checkbox"/> -295 Institutional showerhead (chrome only)</li> <li><input type="checkbox"/> -ADAHS ADA hand shower wand (white)</li> <li><input type="checkbox"/> -B Brass escutcheon (chrome only)</li> <li><input type="checkbox"/> -CHKS Integral check stops - for use in installations where a positive shut-off device is used downstream of mixing valve</li> <li><input type="checkbox"/> -D Brass dome cover (chrome only)</li> <li><input type="checkbox"/> -H321-V 1 mode hand shower unit with slide bar in place of standard hand shower unit</li> <li><input type="checkbox"/> -H323-V 3 mode hand shower unit with slide bar in place of standard hand shower unit</li> <li><input type="checkbox"/> -IPS 1/2" female IPS connections</li> <li><input type="checkbox"/>  -LAM Lever handle</li> <li><input type="checkbox"/>  -LP Loop handle</li> <li><input type="checkbox"/> -L/HD Less showerhead</li> <li><input type="checkbox"/> -L/HS Less hand shower</li> <li><input type="checkbox"/> <b>CG</b> -NS Non-shared diverter valve for 9605 and 9606</li> <li><input type="checkbox"/> -OP 13" oval plate (PLR only)</li> <li><input type="checkbox"/> -QD Quick-disconnect on hand spray units</li> <li><input type="checkbox"/> -R 60" white vinyl hose in place of 60" metal hose</li> <li><input type="checkbox"/> -REB Rebuild trim kit, includes TA-10 and TA-4</li> <li><input type="checkbox"/> -REV Reverse coring, hot on right, cold on left, for back to back installations</li> <li><input type="checkbox"/> -SS Slip spout on any tub/shower unit</li> <li><input type="checkbox"/> -T724 24" slide bar/grab bar with ADA hand shower in place of standard hand shower unit</li> <li><input type="checkbox"/> -T748 48" slide bar/grab bar with ADA hand shower in place of standard hand shower unit</li> <li><input type="checkbox"/> -VB Elevated vacuum breaker</li> <li><input type="checkbox"/> -VP Vandal resistant escutcheon screws in place of standard screws</li> <li><input type="checkbox"/> -X Integral service stops - allows water shutoff at valve for service</li> </ul> <p><b>Note:</b> Append appropriate -suffix to model number.</p> |
| <p><b>Model Numbers</b></p>  |  |
| <ul style="list-style-type: none"> <li><input type="checkbox"/> <b>S-9606-PLR</b><br/><i>Origins tub/shower/hand shower system</i></li> <li><input type="checkbox"/> <b>S-9606-PLR-TRM</b><br/><i>Origins tub/shower/hand shower, trim only</i></li> <li><input type="checkbox"/> <b>S-46-2-BODY</b><br/><i>Temptrol Pressure Balancing tub/shower valve body</i></li> <li><input type="checkbox"/> <b>S-46-2X-BODY</b><br/><i>Temptrol Pressure Balancing tub/shower valve body with stops</i></li> <li><input type="checkbox"/> <b>2DIV-BODY</b><br/><i>Symmons dual outlet diverter valve</i></li> </ul>  |  |
| <p><b>Finish Options</b></p>   |  |
| <ul style="list-style-type: none"> <li><input type="checkbox"/> <b>-STN</b><br/><i>Satin Nickel finish</i></li> </ul>  |  |
| <p><b>Compliance</b></p> <p>-ASME A112.18.1/CSA B125.1</p> <p>-WaterSense 1.5 gpm (5.7 L/min)<br/>2.0 gpm (7.6 L/min)</p>    |  |
| <p><b>Warranty</b></p>   |  |
| <p><b>Limited Lifetime</b> - to the original end purchaser in consumer/residential installations.<br/><b>5 Years</b> - for industrial/commercial installations.<br/>Refer to <a href="http://www.symmons.com/warranty">www.symmons.com/warranty</a> for complete warranty information.</p>   |  |

## Dimensions

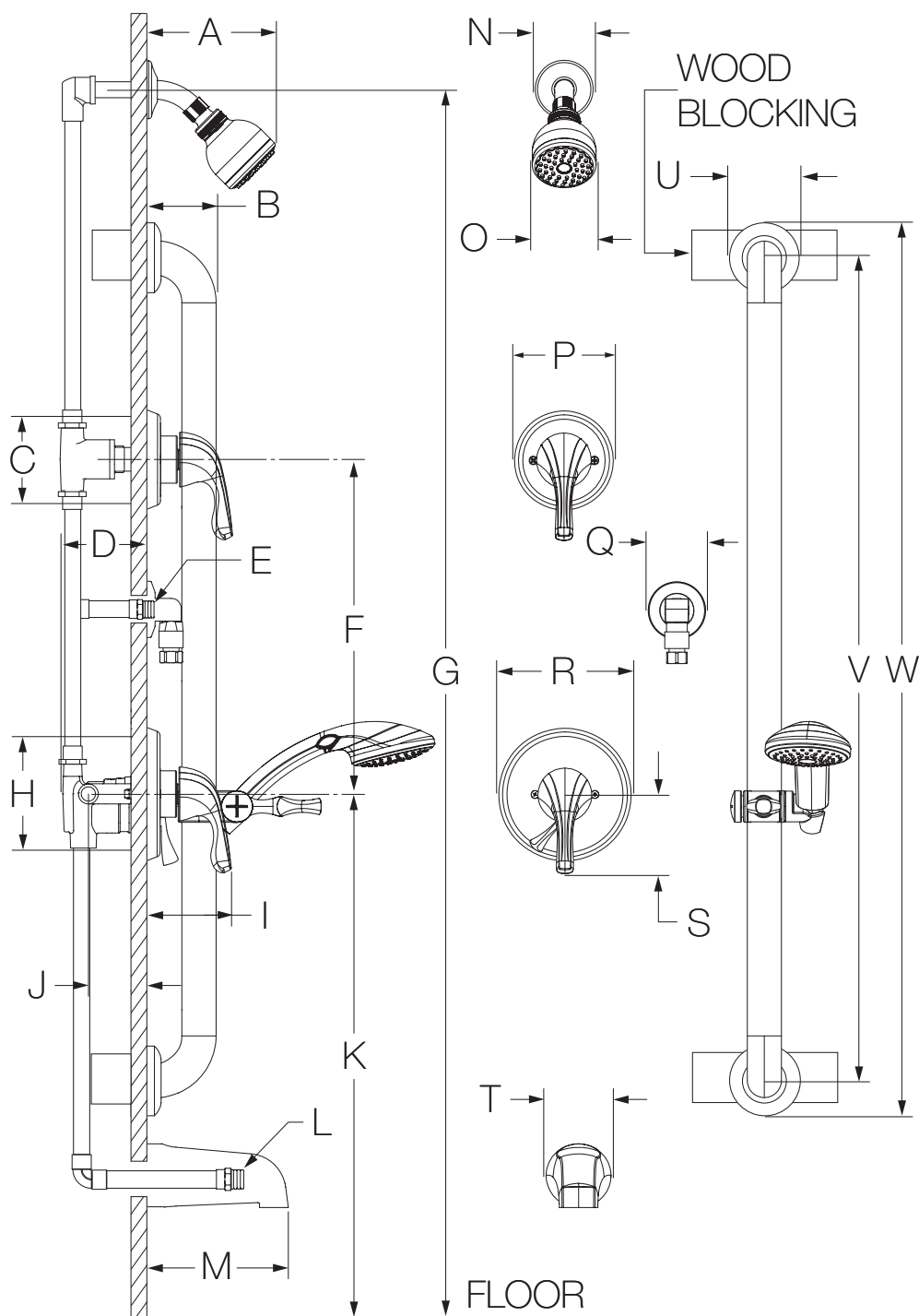







| Measurements |  |
|--------------|--|
| A            | 6-3/8", 162 mm   |
| B            | 3", 76 mm  |
| C            | Diverter Valve Hole Size<br>Min. Ø 3", 76 mm<br>Max. Ø 3-1/4", 83 mm |
| D            | 3-1/2", 89 mm  |
| E            | Male 1/2" NPT fitting must protrude 3/8" from finished wall          |
| F            | Ref. 10", 254 mm   |
| G            | Ref. 77", 1956 mm  |
| H            | Shower Valve Hole Size<br>Min. Ø 3", 76 mm<br>Max. Ø 4", 102 mm      |
| I            | 3-5/8", 92 mm  |
| J            | Rough-in<br>2-3/8" ± 1/2", 60 mm ± 13 mm                             |
| K            | Ref. 32", 813 mm   |
| L            | Male 1/2" NPT fitting must protrude 4" from finished wall            |
| M            | 5-1/2", 140 mm   |
| N            | Ø 2-1/2", 64 mm  |
| O            | Ø 2-3/4", 70 mm  |
| P            | Ø 4-1/4", 108 mm   |
| Q            | Ø 2-1/2", 64 mm  |
| R            | Ø 5-3/4", 146 mm   |
| S            | 3-3/8", 86 mm  |
| T            | Ø 2-1/2", 64 mm  |
| U            | Ø 3-1/8", 79 mm  |
| V            | 36", 914 mm  |
| W            | 39", 991 mm  |

### Notes:

- 1) All dimensions measured from nominal rough-in (see J as reference).
- 2) Dimensions subject to change without notice.

S-9606-PLR  
 Système de baignoire/douche/douche à main  
**Présentation des spécifications**



| Spécification  | Modifications  |
|--|--|
| <p>Le système de baignoire/douche/douche à main comprend la vanne à pression autorégularisée Temptrol® avec déviateur intégré. Figurer la vis d'arrêt réglable pour limiter le tournage de la poignée, une barre de glissement de 36 po, un organe de dérivation deux fonction, un bec de baignoire non-déviateur, un reniflard de ligne, 60 po un tuyau flexible en métal, 1 douche à main et 1 pomme de douche avec facile à nettoyer les buses en caoutchouc et réducteur de débit régulier de 2,5 gpm (9,5 L/min). Les composants sont faits de matériaux métalliques et non métalliques au fini chrome poli standard.</p> <div style="display: flex; justify-content: flex-end; align-items: center;">   </div> |  |
| <p><b>Numéro de modèle</b></p> <p><input type="checkbox"/> <b>S-9606-PLR</b><br/>Système de baignoire/douche/douche à main Origins</p> <p><input type="checkbox"/> <b>S-9606-PLR-TRM</b><br/>Garniture seulement de baignoire/douche/douche à main Origins</p> <p><input type="checkbox"/> <b>S-46-2-BODY</b><br/>Pression autorégularisée Temptrol</p> <p><input type="checkbox"/> <b>S-46-2X-BODY</b><br/>Pression autorégularisée robinet d'interruption du service Temptrol</p> <p><input type="checkbox"/> <b>2DIV-BODY</b><br/>Organe de dérivation deux fonction Symmons</p>  |  |
| <p><b>Options de finition</b></p> <p><input type="checkbox"/> <b>-STN</b><br/>Fini nickel satiné</p>   |  |
| <p><b>Conforme</b></p> <p>-ASME A112.18.1/CSA B125.1</p> <p>-WaterSense 1.5 gpm (5.7 L/min)<br/>2.0 gpm (7.6 L/min)</p> <div style="display: flex; justify-content: flex-end; align-items: center;">   </div>  |  |
| <p><b>Garantie</b></p> <p><b>À vie limitée</b> - à l'acheteur original dans les installations du consommateur ou résidentielles.<br/> <b>5 ans</b> - pour des installations commerciales et industrielles.<br/>     Se reporter au site <a href="http://www.symmons.com/warranty">www.symmons.com/warranty</a> (en anglais) pour l'information complète concernant la garantie.</p>  |  |
|  | <p><input type="checkbox"/> <b>CG</b> -1.5 Régulateur de débit de 1,5 gpm (5,7 L/min)</p> <p><input type="checkbox"/> -2.0 Régulateur de débit de 2,0 gpm (7,6 L/min)</p> <p><input type="checkbox"/> -72 Tuyau de 72 po à la place du tuyau de 60 po</p> <p><input type="checkbox"/> -143 Pomme de douche à 3 modes</p> <p><input type="checkbox"/> -145 Pomme de douche à 5 modes</p> <p><input type="checkbox"/> -231 Super pomme de douche</p> <p><input type="checkbox"/> -295 Pomme de douche institutionnelle</p> <p><input type="checkbox"/> -ADAHS Douche à main ADA (blanc)</p> <p><input type="checkbox"/> -B Vanne de la rosace chrome laiton</p> <p><input type="checkbox"/> -CHKS Valve d'arrêt intégrée</p> <p><input type="checkbox"/> -D Couvercle en dôme chrome laiton</p> <p><input type="checkbox"/> -H321-V Douche à main à 1 mode avec barre coulissante au lieu de l'unité de douche à main standard</p> <p><input type="checkbox"/> -H323-V Douche à main à 3 modes avec barre coulissante au lieu de l'unité de douche à main standard</p> <p><input type="checkbox"/> -IPS Raccords IPS femelles de 1/2 po</p> <p><input type="checkbox"/>  -LAM Poignée du levier</p> <p><input type="checkbox"/>  -LP Poignée de boucle</p> <p><input type="checkbox"/> -L/HD Sans pomme de douche</p> <p><input type="checkbox"/> -L/HS Sans douche à main</p> <p><input type="checkbox"/> <b>CG</b> -NS Inverseur non partagé pour 9605 et 9606</p> <p><input type="checkbox"/> -OP Assiette ovale 13 po</p> <p><input type="checkbox"/> -QD Débranchement rapide pour de douche à main</p> <p><input type="checkbox"/> -R Tuyau de vinyle blanc</p> <p><input type="checkbox"/> -REB L'ensemble de remise en état de la finition, incluant TA-10 et TA-4</p> <p><input type="checkbox"/> -REV Corps central inversé our installations dos à dos</p> <p><input type="checkbox"/> -SS Bec de baignoire à enfiler unité baignoire-douche</p> <p><input type="checkbox"/> -T724 Barre à glissière de 24 po barre d'appui avec douchette à main ADA</p> <p><input type="checkbox"/> -T748 Barre à glissière de 48 po barre d'appui avec douchette à main ADA</p> <p><input type="checkbox"/> -VB Reniflard surélevé</p> <p><input type="checkbox"/> -VP Des vis anti-vandalisme de la rosace remplacent les vis régulières</p> <p><input type="checkbox"/> -X Robinet d'interruption du service</p> |
|  | <p><b>Remarque:</b> Juxtaposer le -suffixe approprié au numéro de modèle.</p>  |

## Dimensions

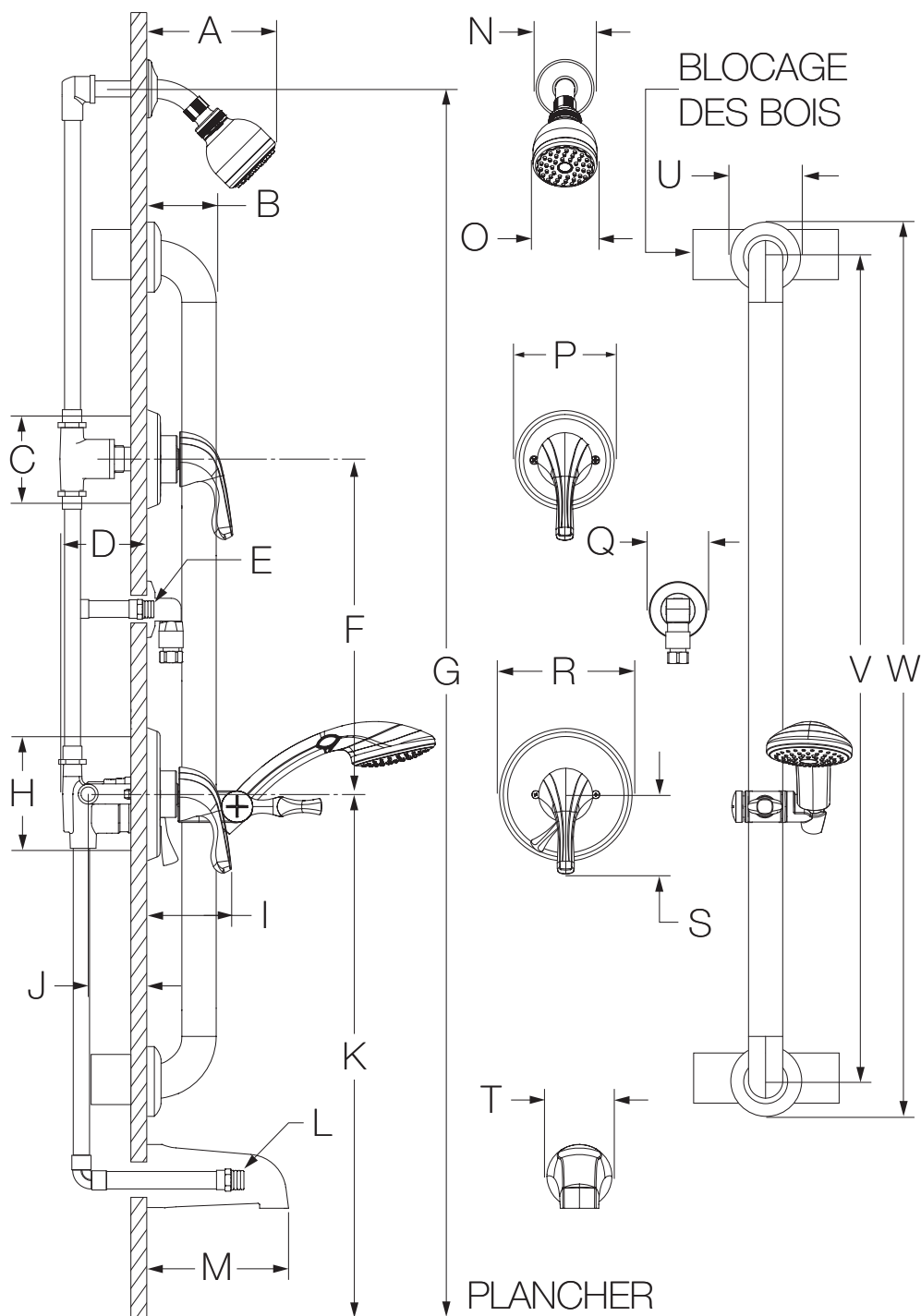

| Mesures |   |
|---------|---|
| A       | 6-3/8 po, 162 mm  |
| B       | 3 po, 76 mm   |
| C       | Taille du trou<br>Min. Ø 3 po, 76 mm<br>Max. Ø 3-1/4 po, 83 mm    |
| D       | 3-1/2 po, 89 mm   |
| E       | 1/2 po mâle à filets NPT doit faire saillie de 3/8 po du mur fini |
| F       | Réf. 10 po, 254 mm  |
| G       | Réf. 77 po, 1956 mm   |
| H       | Taille du trou<br>Min. Ø 3 po, 76 mm<br>Max. Ø 4 po, 102 mm       |
| I       | 3-5/8 po, 92 mm   |
| J       | Robinetterie brute<br>2-3/8 po ± 1/2 po,<br>60 mm ± 13 mm         |
| K       | Réf. 32 po, 813 mm  |
| L       | 1/2 po mâle à filets NPT doit faire saillie de 4 po du mur fini   |
| M       | 5-1/2 po, 140 mm  |
| N       | Ø 2-1/2 po, 64 mm   |
| O       | Ø 2-3/4 po, 70 mm   |
| P       | Ø 4-1/4 po, 108 mm  |
| Q       | Ø 2-1/2 po, 64 mm   |
| R       | Ø 5-3/4 po, 146 mm  |
| S       | 3-3/8 po, 86 mm   |
| T       | Ø 2-1/2 po, 64 mm   |
| U       | Ø 3-1/8 po, 79 mm   |
| V       | 36 po, 914 mm   |
| W       | 39 po, 991 mm   |

### Remarques:

- 1) Toutes les dimensions sont mesurées à partir de la robinetterie brute nominale (voir J en référence).
- 2) Les dimensions sont sujettes à changer sans préavis.